

10BASE-FL to 10BASE-T Converter

GENERAL DESCRIPTION

The fully pin-compatible ML4664/ML4669 pair provide conversion from 10BASE-T copper media to 10BASE-FL fiber media in a single chip. They are compliant with Ethernet IEEE 802.3 10BASE-T and 10BASE-FL standards. The ML4664/69 uses a single 5V supply, and requires no crystal or clock.

Their 10BASE-FL transmitter offers a current drive output that directly drives a fiber optic LED transmitter. Their receiver offers a highly stable fiber optic data quantizer capable of accepting input signals as low as 2mV_{p-p} with a 55dB dynamic range.

The 10BASE-T portion of the pair contains current driven transmitter outputs that offer superior performance because their switching is highly symmetric, resulting in lowered RFI noise and jitter. By changing one external resistor the pair easily interfaces to 100Ω unshielded twisted pair, 150Ω shielded twisted pair, or a range of other characteristic impedances.

The ML4664 does not pass along disconnect information, while the ML4669 does. A loss of light at the optical inputs does not stop link pulses from being sent at the twisted pair transmitter in the ML4664, but in the ML4669 the link pulses stop. Also, a loss of link at the twisted pair inputs will not stop the optical transmitter from sending idle in the ML4664, but the ML4669 stops sending idle.

FEATURES

- Full duplex operation
- Five network status LED outputs
- Industrial temperature option

10BASE-FL FEATURES:

- Highly stable data quantizer with 55dB input dynamic range
- Input sensitivity as low as 2mV_{p-p}
- Up to 100mA maximum current driven fiber optic LED output for accurate launch power (PLCC package)

10BASE-T FEATURES:

- Current driven output for low RFI noise and low jitter
- Drives 100Ω unshielded or 150Ω shielded twisted pair
- Polarity detect status pin capable of driving an LED
- Automatic polarity correction
- On-chip link test with enable/disable option

BLOCK DIAGRAM

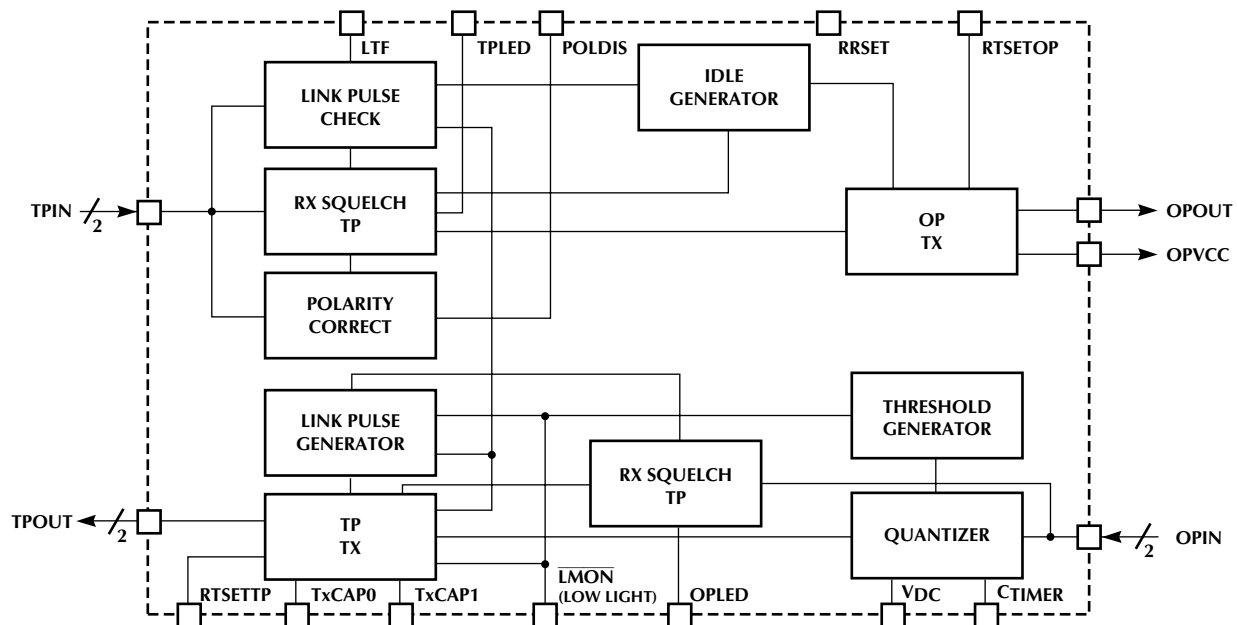

PIN CONFIGURATION

**ML4664/ML4669
28-Pin PLCC (Q28)**

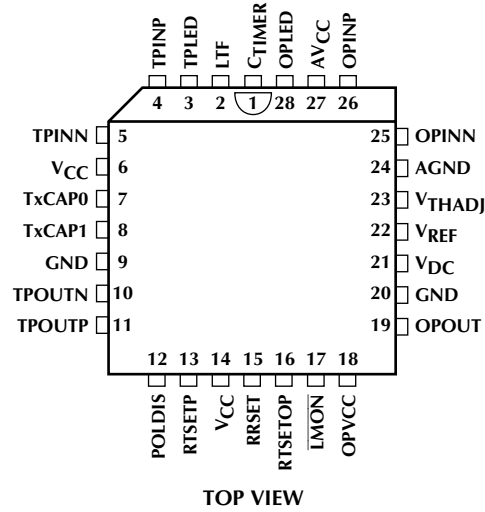

**ML4664/ML4669
32-Pin TQFP (H32-7)**

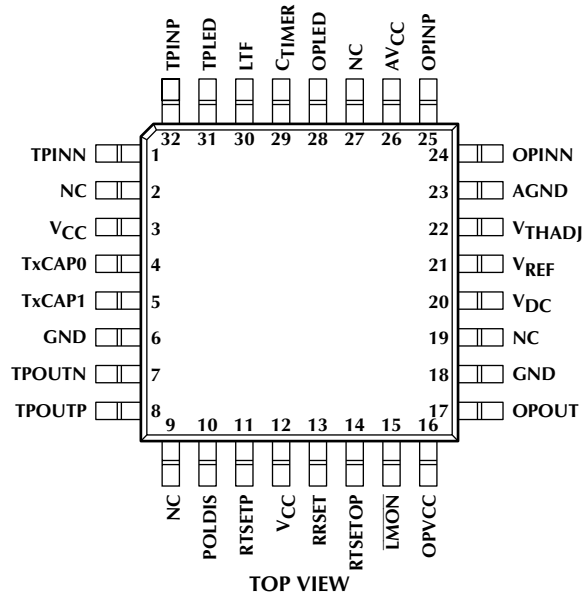

PIN DESCRIPTION (Pin Number in Parentheses is for TQFP Version)

PIN	NAME	FUNCTION	PIN	NAME	FUNCTION
1(29)	C _{TIMER}	A capacitor from this pin to V _{CC} determines the Link Monitor response time.	7(4) 8(5)	TxCAPO TxCAP1	An external capacitor of 680pF is tied between these two pins to set the pulse width for the pre-equalization on the twisted pair transmitter. If these two pins are shorted together, no pre-equalization occurs. If the ML4664/ML4669 is driving only a short cable, or board traces, these pins may be shorted.
2(30)	LTF	<p>Link Test Fail. Active high. Normally this pin is low, indicating that the link is operational. If the link goes down resulting from the absence of link pulses or frames being received, the chip will go into the Link Test Fail state and bring LTF high.</p> <p>When the ML4664 is in the link test fail state, the optical and twisted pair transmitters are disabled from sending data. However, the optical transmitter does send an idle signal, and link pulses are sent at the twisted pair transmitter. When the ML4669 is in link test fail state, the optical and twisted pair transmitters are disabled from sending data. Also, the optical transmitter will not send an idle signal. However, link pulses may be sent at the twisted pair transmitter, depending on the optical inputs. See Table 1.</p> <p>This pin may be grounded to disable Link Test. In this mode no link pulses are sent and the link will not fail if no link pulses are received. If this pin is not used as an LED driver, and is not grounded, a 2kΩ 5% resistor should be connected between this pin and V_{CC}.</p>	9(6) 20(18)	GND	Ground reference
3(31)	TPLED	Indicates that reception is taking place on the TPINP, TPINN pair. Active low LED driver, open collector. It is extended 16ms for visibility. Optionally, this pin may be grounded to disable the optical output. If this pin is not used as an LED driver and is not grounded, a 2k Ω , 5% resistor should be connected between TPLED and V _{CC} .	10(7) 11(8)	TPOUTN TPOUTP	Pre-equalized differential balanced current driven output. These outputs are connected to a balanced transmit output filter which drives the twisted pair cable through pulse transformers. The output current is set with an external resistor connected to RTSET allowing the chip to drive 100 Ω unshielded, 150 Ω shielded twisted pair cables or a range of other characteristic impedances.
4(32) 5(1)	TPINP TPINN	Twisted Pair receive data input. When this signal exceeds the receive squelch requirements the receive data is buffered and sent to the Rx \pm outputs.	12(10)	POLDIS	Receive Polarity status. Active low LED Driver, open collector output. Indicates the polarity of the receive twisted pair regardless of auto polarity correction. When low, receive polarity is reversed. When high, receive polarity is correct. This pin may be grounded to disable the polarity circuit. If this pin is not used as an LED driver, and is not grounded, a 2k Ω , 5% resistor should be connected between this pin and V _{CC} .
6(3) 14(12)	V _{CC}	5V input	13(11)	RTSETTP	When using 100 Ω unshielded twisted pair, a 220 Ω resistor is tied between this pin and V _{CC} . When using 150 Ω shielded twisted pair, a 330 Ω resistor is tied between this pin and V _{CC} .
			15(13)	RRSET	A 1% 61.9k Ω resistor tied from this pin to V _{CC} is used for internal biasing.
			16(14)	RTSETOP	Sets the current driven output of the transmitter. A 115 Ω resistor should be tied between this pin and V _{CC} .

PIN DESCRIPTION (Continued)

PIN	NAME	FUNCTION	PIN	NAME	FUNCTION
17(15)	$\overline{\text{LMON}}$	<p>Link Monitor “Low Light” LED status output. Pulled low when voltage on the OPINP, OPINN inputs exceed min threshold set by V_{THADJ}, and there are transitions on OPINP, OPINN indicating an idle signal or active data. If the voltage on OPINP, OPINN inputs falls below the minimum threshold or transitions cease on OPINP, OPINN, LMON will go high.</p> <p>Active low LED driver, open collector. In the low light state, optical and twisted pair transmitters are disabled from sending data. The optical transmitter of the ML4664 does send an idle signal, and link pulses are sent at the twisted pair transmitter. For the ML4669, the twisted pair transmitter will not send link pulses, the optical transmitter may send an idle signal, depending on inputs. See Table 1.</p>	22(21)	V_{REF}	A 2.5V reference with respect to GND
			23(22)	V_{THADJ}	This input pin sets the link monitor threshold
			24(23)	AGND	Analog Filtered Ground
			25(24)	OPINN	This input pin should be capacitively coupled to filtered AV_{CC} . The input resistance is approximately 1.3k Ω .
			26(25)	OPINP	This input pin should be capacitively coupled to the input source. The input resistance is approximately 1.3k Ω .
			27(26)	AV_{CC}	Analog Filtered 5V
			28(28)	OPLD	Indicates reception is taking place on the OPINP, OPINN pair. Active low LED driver, open collector. It is extended 16ms for usability. This pin may be grounded to disable the twisted pair outputs. If this pin is not used as an LED driver, and is not grounded, a 2k Ω , 5% resistor should be connected between this pin and V_{CC} .
18(16)	OPVCC	5V supply for fiber optic LED driver			
19(17)	OPOUT	Fiber optic LED driver output			
21(20)	V_{DC}	An external capacitor on this pin integrates an error signal which nulls the offset of the input amplifier. If the DC feedback loop is not being used, this pin should be connected to V_{REF} .			

ABSOLUTE MAXIMUM RATINGS

Absolute maximum ratings are those values beyond which the device could be permanently damaged. Absolute maximum ratings are stress ratings only and functional device operation is not implied.

Power Supply Voltage Range

V_{CC}	GND -0.3 to 6V
Input Voltage Range: Digital Inputs (SQEN, LBDIS)	GND -0.3 to $V_{CC} + 0.3V$
$TX+$, $TX-$, V_{IN+} , V_{IN-}	GND -0.3 to $V_{CC} + 0.3V$
Junction Temperature	150°C
Storage Temperature	-65°C to 150°C
Lead Temperature (Soldering)	260°C

Thermal Resistance (θ_{JA})

PLCC	68°C/W
TQFP	80°C/W

OPERATING CONDITIONS

Temperature Range

ML4664/ML4669CX	0°C to 70°C
ML4664/ML4669IQ	-40°C to 85°C
Supply Voltage (V_{CC})	5V \pm 5%
LED on Current	10mA
RRSET	61.9k Ω \pm 1%
RTSETOP	115 Ω \pm 1%
RTSETTP	220 Ω \pm 1%

ELECTRICAL CHARACTERISTICS

Unless otherwise specified, T_A = Operating Temperature Range, $V_{CC} = OPV_{CC} = AV_{CC} = 5V \pm 5%$ (Note 1)

SYMBOL	PARAMETER	CONDITIONS	MIN	TYP	MAX	UNITS	
I_{CC}	Power Supply Current While Transmitting	RTSETOP = 115 Ω			140	mA	
V_{REF}	Reference Voltage	C Suffix	2.30		2.60	V	
		I Suffix	2.25		2.67	V	
V_{OL}	LED Drivers: V_{OL}	$R_L = 300$ for OPLED, TPLED, POLLED LTF, and LMON	1.5		3.5	V	
I_{OPOUT}	OP Transmit Peak Output Current	RTSETOP = 115 (Note 2)	C Suffix	47	52	57	mA
		I Suffix	46		58.5	mA	
I_{TPOUT}	TP Transmit Peak Output Current	RTSETTP = 220		42		mA	
V_{TPSQ}	TP Receive Squelch Voltage		300	450	585	mV _{P-P}	
H_{TP}	TP Receive Squelch Hysteresis			50		%	
V_{TPIN}	TP Receive Input Voltage		300		3100	mV _{P-P}	
R_{TPIN}	TP Receive Input Resistance			4		k Ω	
V_{OPTH}	OP Receive Input Threshold Voltage	$V_{THADJ} = V_{REF}$	5	6	7	mV _{P-P}	
H_{OP}	OP Receive Input Threshold Hysteresis			20		%	
V_{OPIN}	OP Receive Input Voltage		2		1600	mV _{P-P}	
R_{OPIN}	OP Receive Input Resistance		0.8	1.3	2.0	k Ω	
V_{OPCM}	OP Receive Common Mode Voltage			1.65		V	
A_V	Amplifier Gain			100		V/V	
V_{OFF}	Input Offset	$V_{DC} = V_{REF}$ (DC Loop Inactive)		3		mV	
V_N	Input Referred Noise	50MHz Bandwidth		25		μ V	
I_{TH}	Input Bias Current at V_{THADJ}	$V_{THADJ} = V_{REF}$	-200	0	200	μ A	

ML4664/ML4669

ELECTRICAL CHARACTERISTICS (Continued)

SYMBOL	PARAMETER	CONDITIONS	MIN	TYP	MAX	UNITS
OP TO TP (SEE FIGURE 1)						
t_{TPODY}	Twisted Pair Start-up Delay				500	ns
t_{TPSDY}	Twisted Pair Steady State Delay				35	ns
t_{TPSPW}	Twisted Pair Turn Off Pulse Width			180		ns
t_{PS}	Twisted Pair Jitter				± 3.5	ns
TP TO OP (SEE FIGURE 2)						
t_{OPODY}	Optical Transmit Start-up Delay				500	ns
t_{OPSDY}	Steady State Delay				15	ns
t_{OPDI}	Turn Off Width from Data to Idle		400		2100	ns
$1/t_{\text{IDF}}$	Idle Frequency		0.85		1.25	MHz
P_{IDC}	Idle Duty Cycle		45		55	%
t_{OPJ}	Jitter into 31Ω Load				± 1.5	ns
OPTICAL LINK VERIFICATION (SEE FIGURES 3-5)						
t_{OLL}	No Light (No Transitions) to LMON High		3		10	μs
t_{OLM}	Low Light (Below Threshold) to LMON High		50	100	200	μs
t_{OLO}	Light On (Above Threshold, Transitions $< 3\mu\text{s}$) to LMON Low		0.25	0.5	0.75	s
TWISTED PAIR LINK VERIFICATION (SEE FIGURE 6)						
t_{LT}	Link Loss Time		50		150	ms
t_{LTMIN}	Link Time Minimum		2		7	ms
t_{LTMAX}	Link Time Maximum		25		150	ms
LINK PULSE TRANSMIT (SEE FIGURE 7)						
t_{LPRR}	Link Pulse Rep Rate		8	16	24	ms
t_{LPW}	Link Pulse Width		85	120	200	ns
LED TIMING (SEE FIGURE 8)						
t_{LED}	LED on Time		8	16	32	ms

Note 1: Limits are guaranteed by 100% testing, sampling, or correlation with worst-case test conditions.

Note 2: The output current may be increased to 100mA by changing the RTSETOP resistor for the CQ (PLCC) package option only. See equation (1) on page 9. The increased current option is not available for the CH (TQFP) package option.

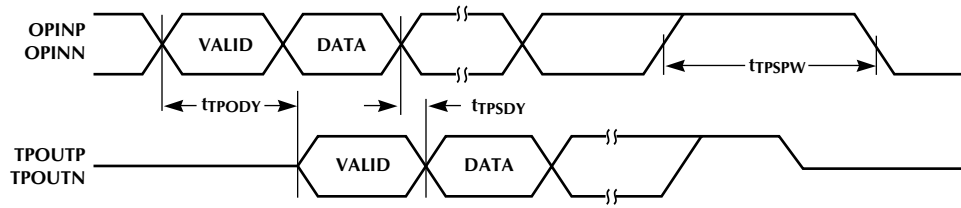

Figure 1. OP to TP Timing Diagram

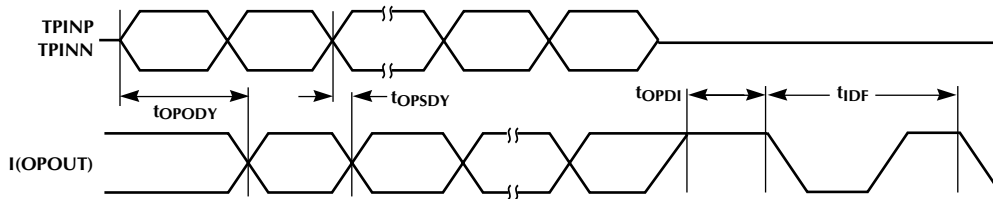

Figure 2. TP to OP Timing Diagram

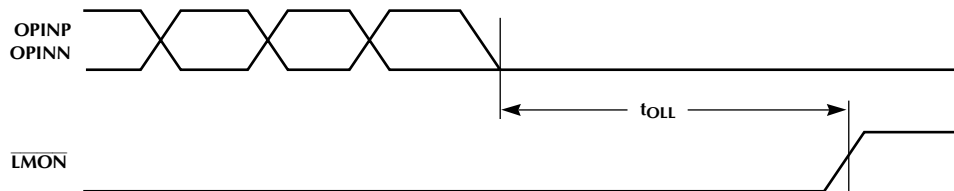

Figure 3. Optical Link Verification No Light Timing Diagram

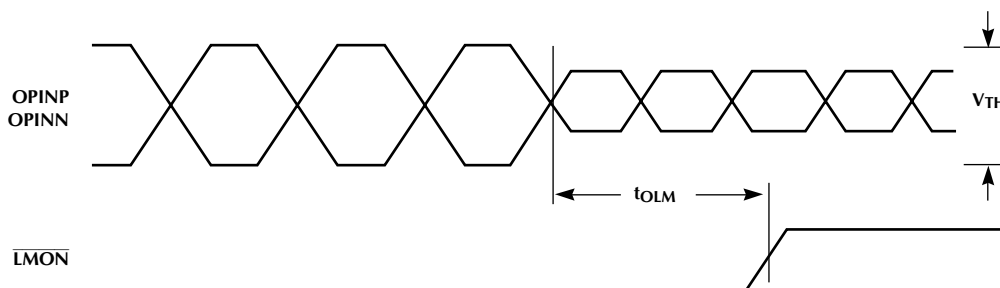

Figure 4. Optical Link Verification Low Light Timing Diagram

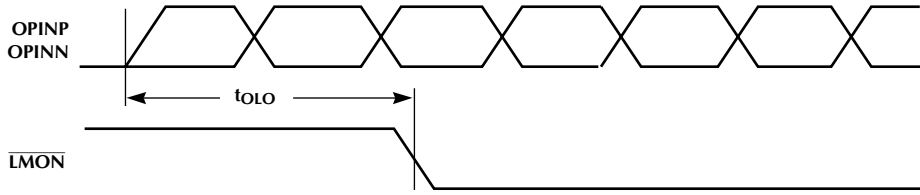

Figure 5. Optical Link Verification Light On Timing Diagram

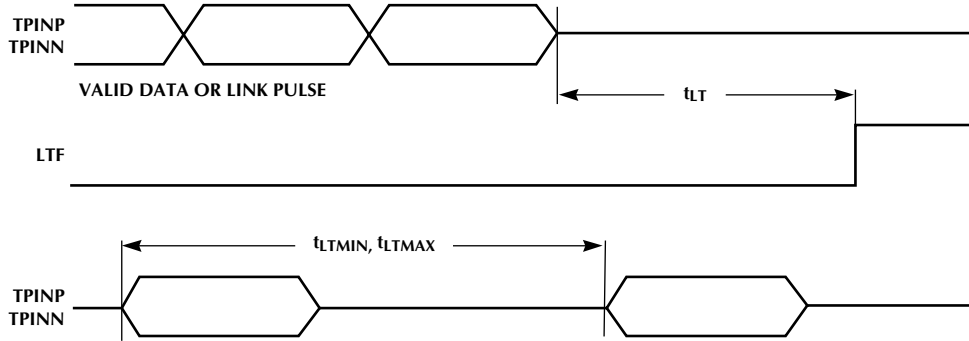

Figure 6. Twisted Pair Link Verification Timing Diagram

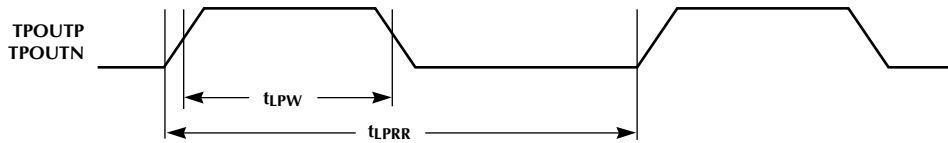

Figure 7. Link Pulse Transmit Timing Diagram

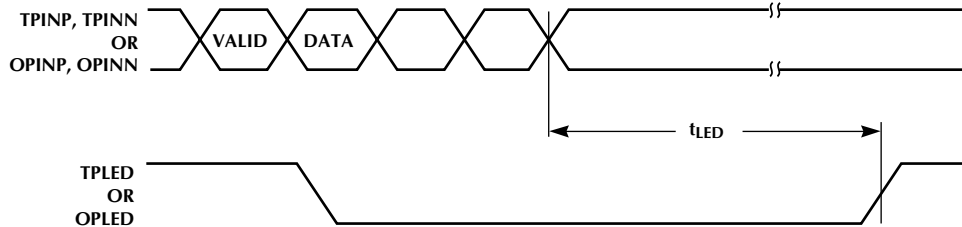

Figure 8. LED Timing Diagram

SYSTEM DESCRIPTION

OPTICAL TRANSMISSION

The optical transmit function consists of detecting the presence of data from the TP inputs TPINP and TPINN and driving that data onto the fiber optic LED transmitter. A positive signal on the TPINP lead relative to the TPINN lead will result in no current, hence the fiber optic LED is in a low light condition. When TPINP is more negative than TPINN, the ML4664/ML4669 will sink current into the chip and the fiber optic LED will light up.

Before data will be transmitted onto the fiber optic cable it must exceed the squelch requirements. The TP inputs, squelch circuit serves the function of preventing any noise from being transmitted onto the fiber.

FIBER OPTIC LED DRIVER

The output stage of the transmitter is a current mode switch which develops the output light by sinking current through the LED into the OPOUT pin. Once the current requirement for the LED is determined, the RTSETOP resistor is selected. The following equation is used to select the correct RTSETOP resistor:

$$RTSETOP = \left(\frac{52\text{mA}}{I_{OUT}} \right) \times 115\Omega \quad (1)$$

The ML4664/ML4669 optical transmitter (in the PLCC package only) is capable of driving up to 100mA maximum which requires resistor RSTETOP to equal 60Ω. (This option is only available with the PLCC package) The transmitter enters the idle state when it detects start of idle on TPINP and TPINN input pins. After detecting the start of idle the transmitter switches to a 1MHz output idle signal.

The output current is switched through the OPOUT pin during the on cycle and the OPVCC pin during the off cycle. Since the sum of the current in these two pins is constant, OPVCC should be connected as close as possible to the V_{CC} connection for the LED.

TP SQUELCH

The twisted pair receive data is transformer coupled and low pass filtered before it is fed into the input pins TPINP and TPINN. The input is differential with the common mode voltage internally set. At the start of packet reception from the twisted pair link, no more than 5 bits are received from the twisted pair cable and not transmitted. The first bit sent at the optical transmitter may contain phase violations or invalid data, but all subsequent bits are valid.

The TP squelch will reject the following signals on the TPINP and TPINN inputs:

1. All signals that produce a peak magnitude less than 300mV (450mV typical).

2. All continuous sinusoidal signals of amplitude less than 6.2V_{P-P} and frequency less than 2MHz.
3. All single sinusoidal cycles of amplitude less than 6.2V_{P-P} and either polarity, where the frequency is between 2MHz and 15MHz. For a period of 4 BT before and after this single cycle, the signal will conform to (1) above.
4. All sinusoidal cycles gated by a 100ns pulse gate of amplitude less than 6.2V_{P-P} and either polarity, where the sinusoidal frequency is between 2MHz and 30MHz. The off time of the pulse gate on the sinusoidal signal shall be at least 400ns.

The first three receive squelch criteria are required to conform to the 10BASE-T standard. The fourth receive squelch criteria exceeds the 10BASE-T requirements and enhances performance. The fourth squelch criteria prevents a false unsquelch caused by cross talk or noise typically found coupling from the phone lines onto the receive twisted pair.

After the TP inputs are unsquelched, the detection threshold is lowered to 225mV. Upon passing the TP squelch requirements the receive data passes to the LED Driver. The addition of jitter through the TP to OP path is no more than ±1.5ns.

While in the unsquelch state, the TP squelch circuit looks for the start of idle signal at the end of the packet. When start of idle is detected, TP squelch is turned on again. The proper start of idle occurs when the input signal remains above 300mV for 160ns.

LINK TEST FUNCTION

Transmission — Whenever data is not being delivered to the twisted pair link, the idle signal is applied. The idle signal is a sequence of Link Pulses separated by a 16ms period of silence. The idle signal starts with a period of silence after a packet transmission ends. The link test pulse is a single high pulse with the same amplitude requirements as the data signal.

Reception — The transceiver monitors the receive twisted pair input for packet and link pulse activity. If neither a packet nor a link test pulse is received for 50 to 150ms, the transceiver enters the Link Test Fail state and inhibits transmission and reception. Link pulses received with the wrong polarity will be ignored and cause the chip to go into link test fail.

When a packet, or five consecutive link test pulses is received from the twisted pair input, the transceiver will exit the Link Test Fail state upon transmit and receive data being idle, and re-enable transmission and reception.

SYSTEM DESCRIPTION (Continued)

Link test pulses that do not occur within at most 25 to 150ms of each other are not considered consecutive. In addition, detected pulses that occur within a time between 2 to 7ms of a previous pulse will be considered as noise by the link test circuitry, and will reset the count of consecutive link pulses to zero.

If the ML4664 enters the link test fail state, both link pulses at the twisted pair transmitter, and idle at the optical transmitter will continue to be sent. Data will not be sent at either transmitter.

If the ML4669 enters the link test fail state, idle will not be sent at the optical transmitter. Data will not be sent at either transmitter. However, link pulses may still be sent at the twisted pair transmitter, depending on the optical inputs. See Table 1.

POLARITY CIRCUITRY

The ML4664/ML4669 offers automatic polarity correction. The POLDIS pin is used to report the status of the receive pair polarity. This pin is high when the polarity is correct, and low when the polarity is reversed. If this pin is grounded, the polarity correction circuit is disabled.

Polarity Detection — The internal circuitry uses the start of idle signal to determine the receive polarity. With the correct receive polarity, the Start of Idle signal (the end of the frame) will remain above 300mV for more than 160ns. If the polarity is reversed, the Start of Idle signal will end with a negative voltage.

The POLDIS status pin is updated only when four consecutive frames are received with the same Start of Idle polarity. In the case where the part is powered up with the receive polarity reversed and no frames are received, the part will go into link test fail without reflecting a reverse polarity condition. If five consecutive revised link pulses are then received, the polarity will reverse and the device will come out of Link Test Fail.

TP TRANSMISSION

The TP transmit function consists of detecting the presence of data from the OP inputs, OPINP and OPINN and driving that data onto the transmit twisted pair (TPOUTP, TPOUTN). A positive signal on the OPINP lead relative to the OPINN lead will result in a positive signal on the TPOUTP lead of the chip with respect to the TPOUTN lead.

Before data will be transmitted onto the twisted pair from the OP inputs, it must exceed the squelch requirements for the OP inputs. The OP squelch circuit serves the function of preventing any noise from being transmitted onto the twisted pair.

The output stage of the transmitter is a current mode switch which develops the output voltage by driving current through the terminating resistor and the output filter. The transmitter employs a center tap 2:1 transformer where the center tap is tied to V_{CC} (+5V). While one pin of the transmit pair (TPOUTP, TPOUTN) is pulled low, the other pin floats. The output pins to the twisted pair wires,

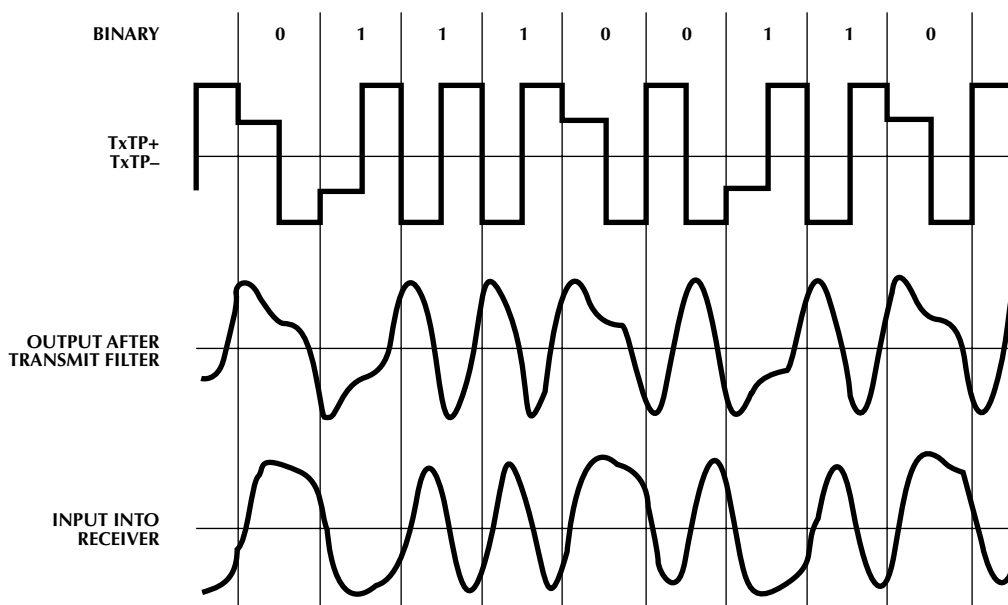

Figure 9. Transmit Pre-Equalization Waveform

SYSTEM DESCRIPTION (Continued)

TPOUTP and TPOUTN, can drive a 100Ω, 150Ω load, or a variety of impedances that are characteristic of the twisted pair wire. RTSETTP selects the current into the TPOUTP, TPOUTN pins. This current along with the characteristic impedance of the cable determines the output voltage.

Once the characteristic impedance of the twisted pair is determined, one must select the appropriate RTSETTP resistor as well as match the terminating impedances of the transmit and receive filter. The RTSETTP resistor can be selected as follows:

$$RTSETTP = \left(\frac{R_L}{100} \right) \times 220\Omega \quad (2)$$

Where R_L is the characteristic impedance of the twisted pair cable.

The transmitter incorporates a pre-equalization circuit for driving the twisted pair line. Pre-equalization compensates for the amplitude and phase distortion introduced by the twisted pair cable. The twisted pair line will attenuate the 10MHz signal more than the 5MHz signal. Therefore pre-equalization insures that both the 5 and 10MHz components will be roughly the same amplitude at the far end receiver.

The pre-equalization circuit reduces the current output when a 5MHz bit is being transmitted. After 50ns of a 5MHz bit, the current level is reduced to approximately 2/3 of its peak for the remaining 50ns. Figure 9 illustrates the pre-equalization.

An on-chip one-shot determines the pulse width of the pre-equalized transmit signal. This requires an external capacitor connected to pins TxCAP0 and TxCAP1. The proper value for this one-shot is 680pF. Pre-equalization can be disabled by shorting TxCAP0 and TxCAP1 together.

The transmitter enters the idle state when it detects start of idle on OPINP and OPINN input pins. The transmitter maintains a minimum differential output voltage of at least 450mV for 250ns after the last low to high transition. The driver differential output voltage will then be within 50mV of 0V within 45 bit times.

OP SQUELCH

The input to the optical receiver comes from a fiber optic pre-amp. At the start of packet reception no more than 2.7 bits are received from the fiber cable and not transmitted onto the TP outputs. The receive squelch will reject frequencies lower than 2.51MHz.

While in the unsquelch state, the receive squelch circuit looks for the start of idle signal at the end of the packet. Start of idle occurs when the input signal remains idle for more than 160ns. When start of idle is detected, the receive squelch circuit returns to the squelch state and the start of idle signal is output on the twisted pair outputs TPOUTP, TPOUTN.

INPUT AMPLIFIER

The OPINP, OPINN input signal is fed into a limiting amplifier with a gain of about 100 and input resistance of 1.3kΩ. Maximum sensitivity is achieved through the use of a DC restoration feedback loop and AC coupling the input. When AC coupled, the input DC bias voltage is set by an on-chip network at about 1.7V. These coupling capacitors, in conjunction with the input impedance of the amplifier, establish a high pass filter with 3dB corner frequency, f_L , at:

$$f_L = \frac{1}{2\pi \times 1300C} \quad (3)$$

Since the amplifier has a differential input, two capacitors of equal value are required. If the signal driving the input is single ended, one of the coupling capacitors can be tied to AV_{CC} .

The internal amplifier has a lowpass filter built-in to band limit the input signal which in turn will improve the signal to noise ratio.

Although the input is AC coupled, the offset voltage *within* the amplifier will be present at the amplifier's output. In order to reduce this error a DC feedback loop is incorporated. This negative feedback loop nulls the offset voltage, forcing V_{OS} to be zero. Although the capacitor on V_{DC} is non-critical, the pole it creates can effect the stability of the feedback loop. To avoid stability problems, the value of this capacitor should be at least 10 times larger than the input coupling capacitors.

The comparator is a high-speed differential zero crossing detector that slices and accurately digitizes the receive signal. The output of the comparator is fed into the receive squelch circuit.

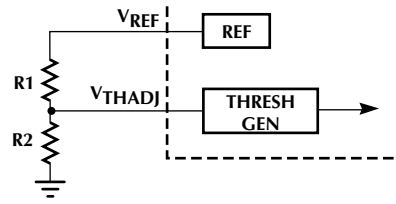

Figure 10.

INPUTS		OUTPUTS					
TPIN	OPIN	OPOUT	TPOUT	STATUS LEDs			
				LTF	$\overline{\text{LMON}}$	TPLED	OPLED
None	None	None (Idle)	None (LPS)	OFF	OFF	OFF	OFF
LPS	None	Idle	None (LPS)	ON	OFF	OFF	OFF
Data	None	Idle	None (LPS)	ON	OFF	ON	OFF
None	Idle	None (Idle)	LPS	OFF	ON	OFF	OFF
LPS	Idle	Idle	LPS	ON	ON	OFF	OFF
Data	Idle	Data	LPS	ON	ON	ON	OFF
None	Data	None (Idle)	LPS	OFF	ON	OFF	ON
LPS	Data	Idle	Data	ON	ON	OFF	ON
Data	Data	Data	Data	ON	ON	ON	ON

LPS = Link Pulses

ON = Low

OFF = High

Some simplifications made regarding $\overline{\text{LMON}}$ and LTF state machines, see system description.

Table 1. ML4669 Functionality. Differences in parentheses are for the ML4664.

SYSTEM DESCRIPTION (Continued)

OPTICAL LINK DETECT CIRCUIT AND LOW LIGHT

The link detect circuit monitors the input signal and determines when the input falls below a preset voltage level. When the input falls below a preset voltage, the ML4664/ML4669 goes into the Low Light state. In the Low Light state the TP transmitter is disabled, but continues sending link pulses, the receiver is disabled, and the $\overline{\text{LMON}}$ LED pin goes to high shutting off the $\overline{\text{LMON}}$ LED. To return to the Link Pass state, the optical receiver power must be 20% higher than the shut-off state. This built-in hysteresis adds stability to the Link Monitor circuit. Once the receiver power threshold is exceeded, the ML4664/ML4669 waits 250ms to 750ms, then checks to see that no data is being received before re-enabling the transmitter, and receiver, and lighting up the $\overline{\text{LMON}}$ LED.

When the ML4664 is in the low light state, both the link pulses at the twisted pair transmitter and idle at the optical transmitter continue to be sent. However, when the ML4669 is in the low light state, link pulses are not sent at the twisted pair transmitter. Data is not sent at either transmitter. An idle signal may be sent at the optical transmitter, depending on the twisted pair inputs. See Table 1.

The V_{THADJ} pin is used to adjust the sensitivity of the receiver. The ML4664/ML4669 is capable of exceeding the 10BASE-FL specifications for sensitivity. The sensitivity is dependent on the layout of the PC board. A good low noise layout will exceed the 10BASE-FL specifications, while a poor layout will fail to meet the sensitivity and BER spec.

The threshold generator shifts the reference voltage at V_{THADJ} through a circuit which has a temperature coefficient matching that of the limiting amplifier. The relationship between the V_{THADJ} and the V_{TH} (the peak to peak input threshold) is:

$$V_{\text{THADJ}} = 408V_{\text{TH}} \quad (4)$$

A 10BASE-FL receiver must make less than 1×10^{-9} bit errors at a receive power level of -32.5dBm average. One procedure to determine the sensitivity of a receiver is to start at the lowest optical power level and gradually increase the optical power until the BER is met. In this

case the Link Detect circuit must not disable the receiver (i.e. V_{THADJ} should be tied to 1.0V). Once the sensitivity of the receiver is determined, V_{THADJ} can be set just above the power level that meets the BER specification. This way the receiver will shut-off before the BER is exceeded.

For 10BASE-FL V_{THADJ} can be tied directly to V_{REF} . However if greater sensitivity is required the circuit in Figure 10 can be used to adjust the V_{THADJ} voltage. Even if V_{REF} is tied to V_{THADJ} , it is a good idea to layout a board with these two resistors available. This will allow potential future adjustments without board revisions.

The response time of the Link Detect circuit is set by the C_{TIMER} pin. Starting from the link off state the link can be switched on if the input exceeds the set threshold for a time given by:

$$T = \frac{C_{\text{TIMER}} \times 0.7V}{700\mu\text{A}} \quad (5)$$

To switch the link from on to off, the above time will be doubled. A value of $0.05\mu\text{F}$ will meet to 10BASE-FL specifications.

LED DRIVERS

The ML4664/ML4669 has five LED drivers. The LED driver pins are active low, and the LEDs are normally off (except for LTF and $\overline{\text{LMON}}$). The LEDs are tied to their respective pins through a 300Ω resistor to 5 Volts.

The OPLED and TPLED pins have pulse stretchers on them which enables the LEDs to be visible. If another event occurs before the timer expires, the LED timer will reset and restart the timing. Therefore rapid events will leave the LEDs continuously on. The $\overline{\text{LMON}}$, LTF, and POLDIS LEDs do not have a pulse stretcher on since its condition occurs long enough for the eye to see.

LOW LIGHT CONDITION

The $\overline{\text{LMON}}$ LED output is used to indicate a low light condition. $\overline{\text{LMON}}$ is activated low when both the receive power exceeds the Link Monitor threshold and there are transitions on OPINP, OPINN less than $3\mu\text{s}$ apart. If either one of these conditions do not exist, $\overline{\text{LMON}}$ will go high.

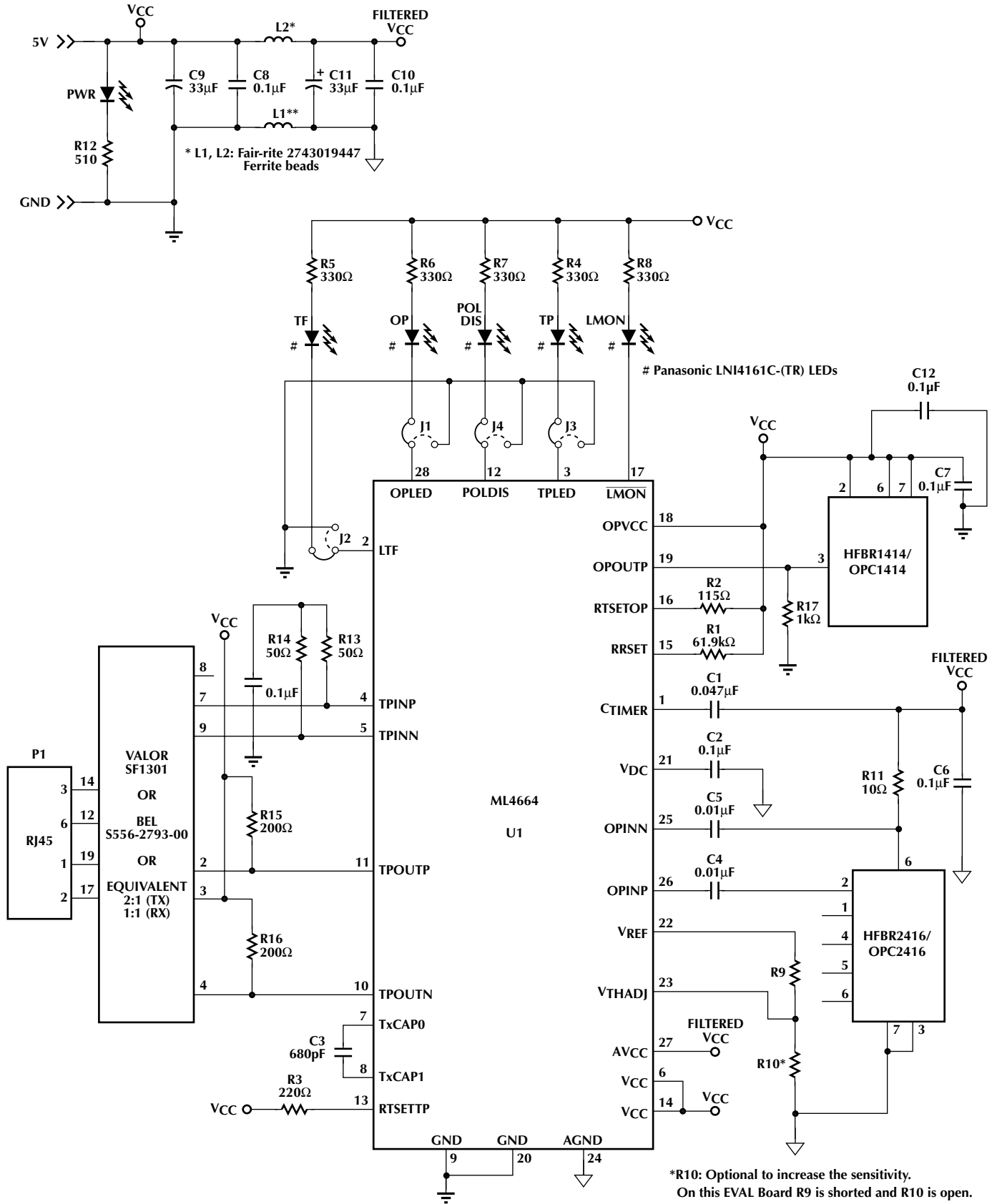
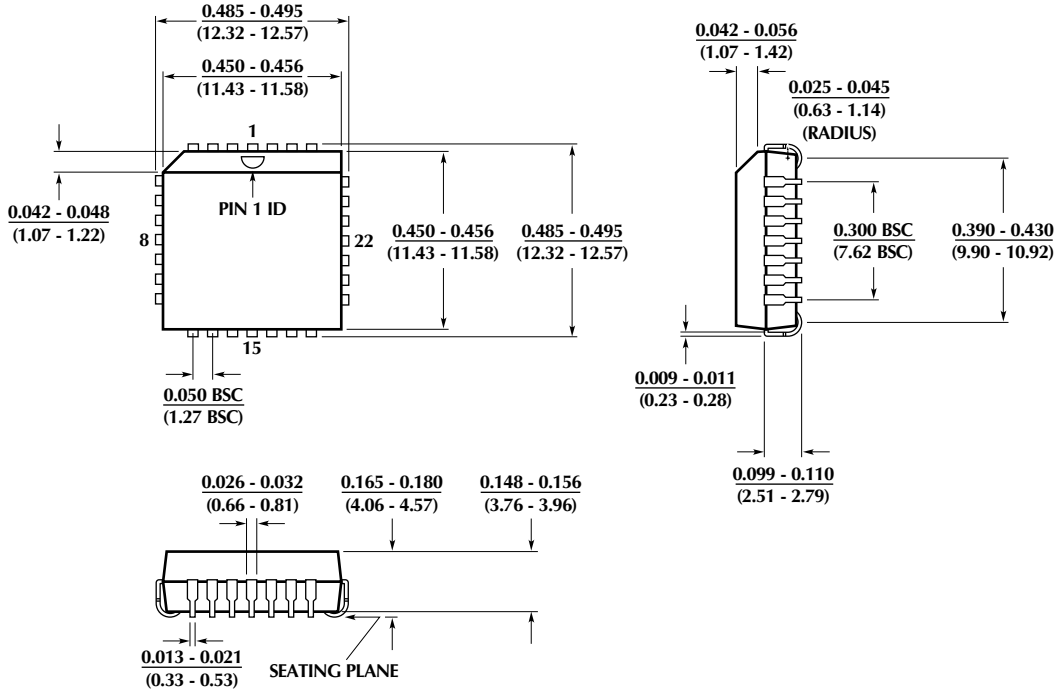

Figure 11. Typical Application Circuit.

PHYSICAL DIMENSIONS inches (millimeters)

Package: Q28
28-Pin PLCC



Package: H32-7
32-Pin (7 x 7 x 1mm) TQFP

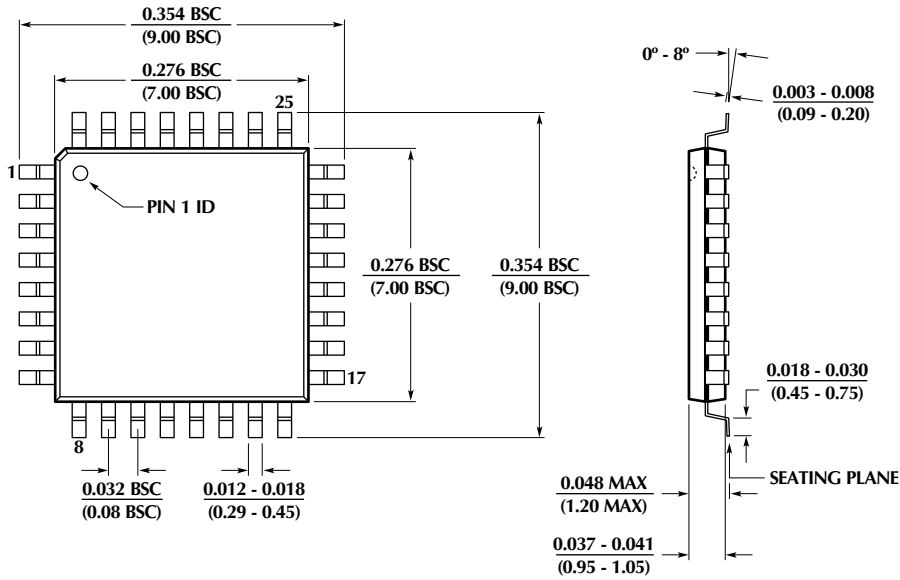

ORDERING INFORMATION

PART NUMBER	TEMPERATURE	PACKAGE
ML4664CH	0°C to 70°C	32-Pin TQFP(H32-7)
ML4664CQ	0°C to 70°C	Molded 28-Pin PLCC (Q28)
ML4664IQ	-40°C to 85°C	Molded 28-Pin PLCC (Q28)
ML4669CH	0°C to 70°C	32-Pin TQFP(H32-7)
ML4669CQ	0°C to 70°C	Molded 28-Pin PLCC (Q28)
ML4669IQ	-40°C to 85°C	Molded 28-Pin PLCC (Q28)

© Micro Linear 1998.  **Micro Linear** is a registered trademark of Micro Linear Corporation. All other trademarks are the property of their respective owners.

Products described herein may be covered by one or more of the following U.S. patents: 4,897,611; 4,964,026; 5,027,116; 5,281,862; 5,283,483; 5,418,502; 5,508,570; 5,510,727; 5,523,940; 5,546,017; 5,559,470; 5,565,761; 5,592,128; 5,594,376; 5,652,479; 5,661,427; 5,663,874; 5,672,959; 5,689,167; 5,714,897; 5,717,798; 5,742,151; 5,747,977; 5,754,012; 5,757,174; 5,767,653; 5,777,514. Japan: 2,598,946; 2,619,299; 2,704,176. Other patents are pending.

Micro Linear reserves the right to make changes to any product herein to improve reliability, function or design. Micro Linear does not assume any liability arising out of the application or use of any product described herein, neither does it convey any license under its patent right nor the rights of others. The circuits contained in this data sheet are offered as possible applications only. Micro Linear makes no warranties or representations as to whether the illustrated circuits infringe any intellectual property rights of others, and will accept no responsibility or liability for use of any application herein. The customer is urged to consult with appropriate legal counsel before deciding on a particular application.

2092 Concourse Drive
San Jose, CA 95131
Tel: 408/433-5200
Fax: 408/432-0295
www.microlinear.com



Micro Linear

To receive a price quote or to request a product sample, call or send e-mail to your local representative.

When sending e-mail, be sure to include the Micro Linear part number and whether you want a price quote or a sample in the subject line.

(i.e. subject: Sample request - ML part#xxxx)

[Click here to find your local representative](#)

